

***Bag Tapers & Tape Dispensers***

***Busch Tool Kits ♦ Butcher Paper***

***Cleaners & Lubricants***

***Clothing & Protective Wear***

***Cutlery & Accessories ♦ Facilities Sanitation***

***Hoses & Nozzles ♦ Material Handling***

***Packaging Supplies ♦ Retail Display***

***Scales ♦ Sealers & Wrappers***

***Sharpeners & Stones***

***Smokehouse Accessories***

***Staplers & Paper Cutters ♦ Steel It Paint***

***Thermometers***

***Work Tables & Sinks***

We provide  
technical support and  
service for all machines  
that we sell.



**MPBS**  
INDUSTRIES

**Commercial Food Processing & Packaging Equipment**

2820 E. Washington Blvd., Los Angeles, CA 90023  
323-268-8514 800-421-6265 323-386-4058 (fax)  
[www.mpbsonline.com](http://www.mpbsonline.com)



Since 1938

# **MPBS** INDUSTRIES About MPBS Industries

---

The Company that was to become MPBS Industries was first established in Germany in 1898 to market butcher supplies. It was re-established by its founders in Los Angeles, California in 1938 as a full-service equipment provider to the meat industry. Today MPBS Industries is a manufacturer and distributor of equipment and supplies for food processors in the United States and around the globe.

Our product lines include items for grinding, mixing, blending, portioning, injecting, tumbling, filling, slicing, smoking and packaging. Equipment sales are supported by our technicians and by a substantial inventory of machine replacement parts. Food plant and butcher supplies (hand tools, cutlery, clothing, material handling, packaging materials) are offered through our catalog sales department.

Our experienced technical staff can assist you in selecting and implementing a single item or a complete production line.

**Follow us on**



**MPBSIndustries**



# BAG TAPER & TAPE DISPENSERS



**Tape Moistener Express** (70770)  
**White Gummed Tape 1½" x 500"** (70780)  
**Safe Handling Tape 1½" x 500"** (70782)



**Tape Dispenser** (42213)  
**Blue Tape** (42214)  
**Red Tape** (42215)  
**Yellow Tape** (42216)



**Tape Dispenser**  
(70771)



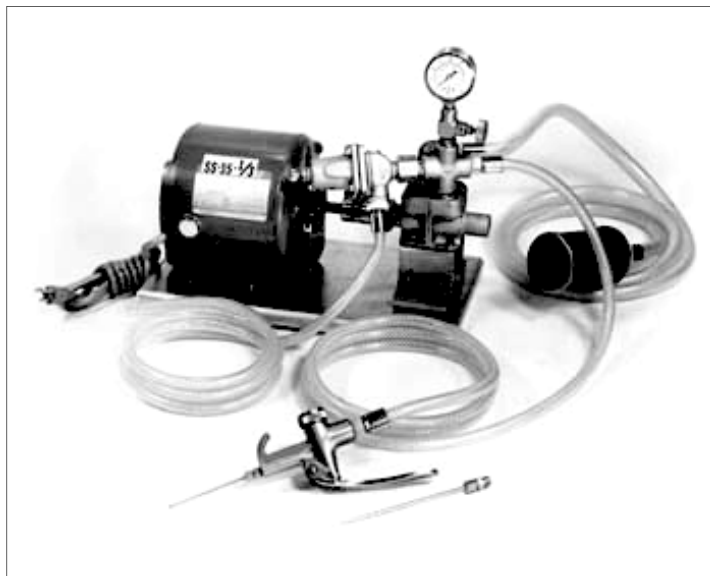

Brine Pump - Brass  
BP-1 Single Operator: 70645  
BP-2 Two Operators: 70649



Brine Pump - Stainless Steel  
Totally Enclosed  
BPST-1 Single Operator: 70646  
BPST-2 Two Operators: 70646-02

Brine Pump - Stainless Steel  
BPS-1 Single Operator: 70648  
BPS-2 Two Operators: 70647



# MPBS Industries Brine Pump and Accessories 2

EXTRA LONG SOLID POINTS CAN BE RESHARPENED MANY TIMES

OUR SPRAY NEEDLES WILL OUTLAST ALL ORDINARY TYPES FIVE TO ONE

USE THIS CHART IN CHOOSING THE RIGHT O.D. THICKNESS WHEN ORDERING YOUR NEEDLES

**NOTE CAREFULLY:**

1. Nine Thicknesses of Artery Needles.
2. Twelve Sizes of Long Point Spray Needles with Different Sizes and Number of Holes.

DECIMAL EQUIVALENTS

1/64 .0156	9/64 .1406
1/32 .0312	5/32 .1562
3/64 .0468	11/64 .1718
1/16 .0625	3/16 .1875
5/64 .0781	13/64 .2031
3/32 .0937	7/32 .2187
7/64 .1093	15/64 .2343
1/8 .125	1/4 .25

**IMPORTANT**  
ONLY TYPE "V" NEEDLES FIT DIRECTLY INTO HAND VALVES

Long Point, Artery Needles  
are Hollow-Ground for Sharper Tips

V - Spray Needles		
Item No.	Description	Size
70670	V - SS spray needle	SNA 7 1/2-V.187
70670-02	V - SS spray needle	SNA 6-V.187
70670-03	V - SS spray needle	SNC 6-V-.148
70671	V - SS spray needle	SNE 6-V-.125
70671-02	V - SS spray needle	SNE 7 1/2-V-.125
70672	V - SS spray needle	SNE 4 1/2-V-.125
70673	V - SS spray needle	SNE 3 1/2-V-.125

Artery Needles		
Item No.	Description	Size
70674	Artery needle	ANA 3 1/2-V
70675	Artery needle	ANC 3 1/2-V
70676	Artery needle	ANE 3 1/2-V
70676-02	Artery needle	ANF 3 1/2-V.109
70676-03	Artery needle	ANG 3 1/2-V.095
70676-04	Artery needle	ANH 3 1/2-V-.083
70676-05	Artery needle	ANI 3 1/2-V-.072

**IMPORTANT**  
ONLY TYPE "H" NEEDLES FIT MULTIPLE NEEDLE HOLDERS

H - Spray Needles		
Item No.	Description	Size
70666	H - SS spray needle	SNA 7 1/2-H-.187
70667	H - SS spray needle	SNE 6-H-.125
70667-02	H - SS spray needle	SNA 6-H-.187
70668	H - SS spray needle	SNE 4 1/2-H.125
70669	H - SS spray needle	SNE 3 1/2-H.125



**AVAILABLE IN TWO SIZES**

**2-NH.-1 5/8 | 2-NH.-2 3/4**

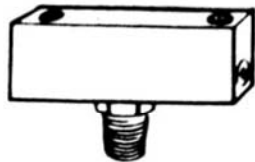

**AVAILABLE IN TWO SIZES**

**3-NH.-1 3/8 | 3-NH.-1 3/4**

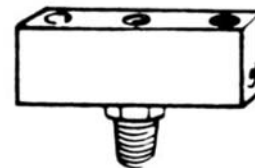

**AVAILABLE IN TWO SIZES**

**4-NH.-7/8 | 4-NH.-1 1/8**

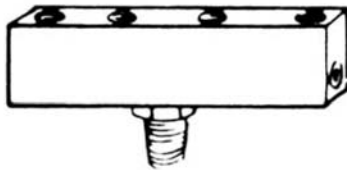

**NEEDLE HOLDER**

**5-NH.-1 1/8**

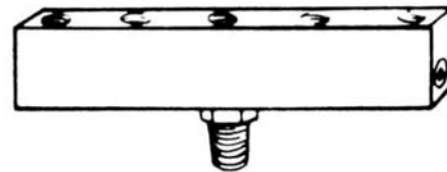

Needle Holders		
Item No.	Description	Size
70656	2 Holes needle holder	2-NH-1 5/8
70657	2 Holes needle holder	2-NH-2 3/4
70658	3 Holes needle holder	3-NH-1 3/8
70659	3 Holes needle holder	3-NH-1 3/4
70660	4 Holes needle holder	4-NH-7/8
70661	4 Holes needle holder	4-NH-1 1/8
70662	5 Holes needle holder	5-NH-7/8
70663	5 Holes needle holder	5-NH-1 1/8

**NEEDLE HOLDER ONLY 5-NH.-7/8**

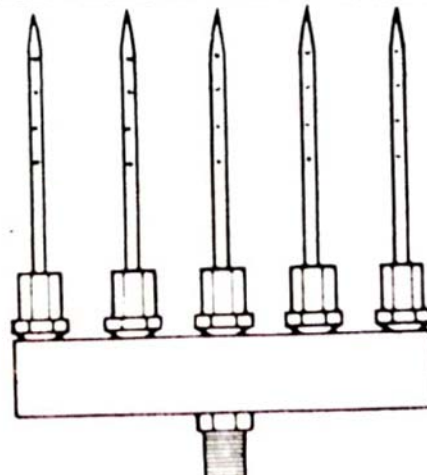

# MPBS Industries Brine Pump and Accessories 4

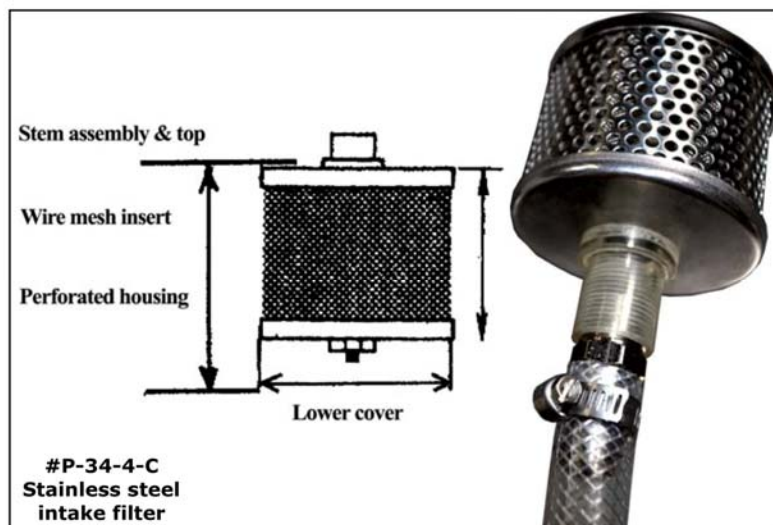
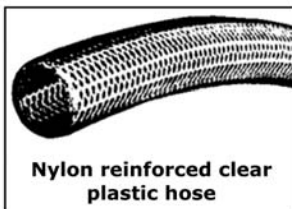
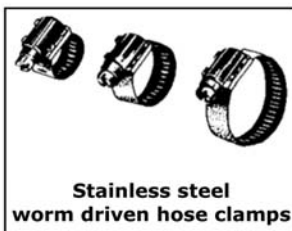
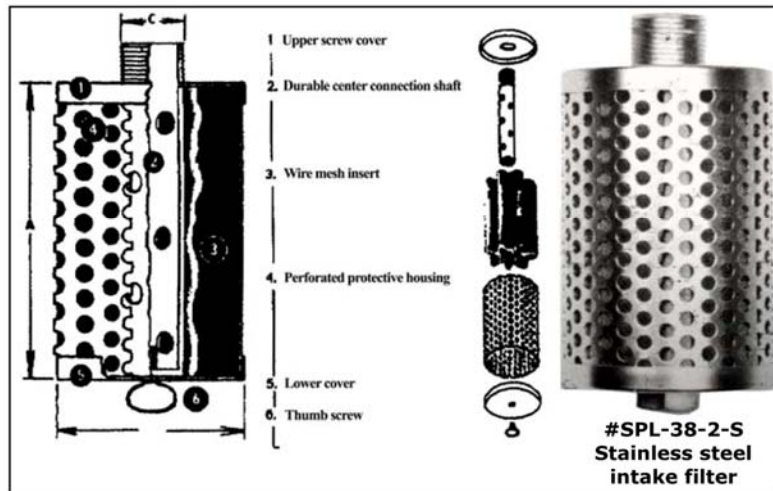
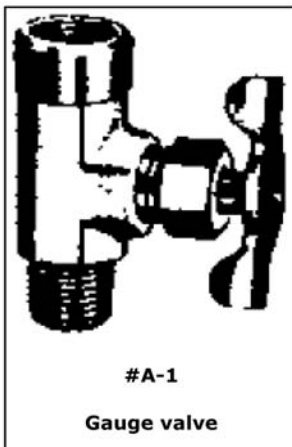
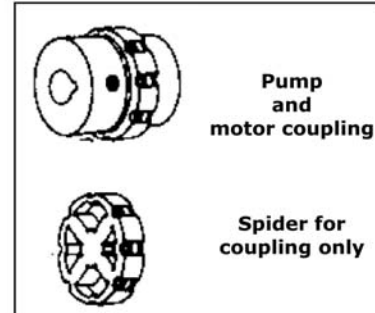
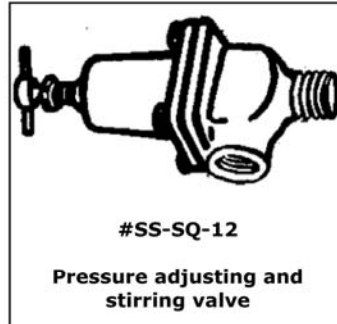
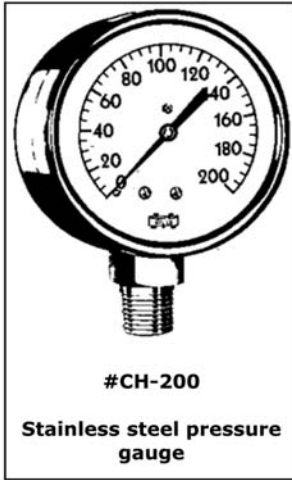

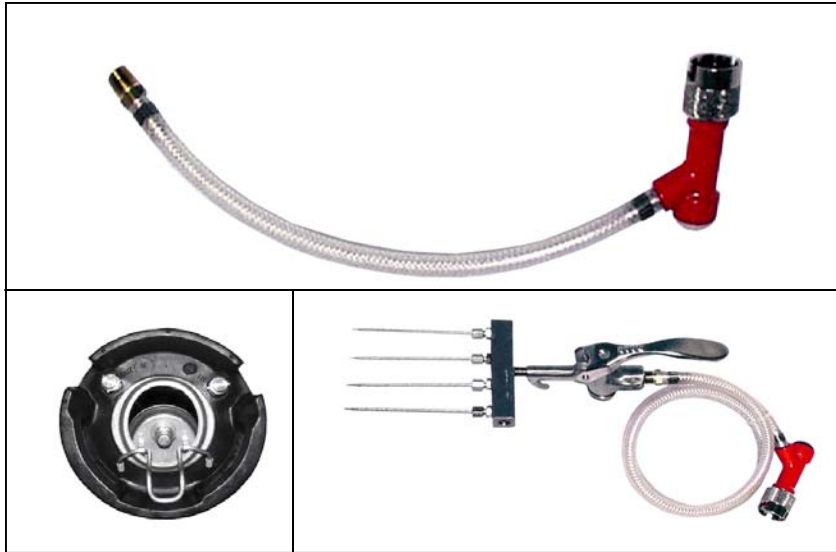

**BP Brine Pump Table**  
(70679-BP)



**BP 500 Brine Pump**  
(70690-BP500)





# MPBS INDUSTRIES Brine Pump and Accessories 6



Hand Operated Brine Pump  
(70644)



Brine Pump Agitator  
(70824, 70825)



BP 1000 Brine Pump  
(70690-BP1000)



# MPBS INDUSTRIES BUTCHER SUPPLIES 1



**Aluminum Stuffing Tubes 1/2" Tip**  
(40119, 40121, 40135)



**Aluminum Stuffing Tubes 3/4" Tip**  
(40120, 40122, 40136)



**Stainless Steel Stuffing Tubes**  
(40108, 40109, 40110)



**F. Dick Filling Tubes**  
(40115)



**Sausage Press Extruder**  
(41983)

**Waxed Paper**  
(41983-10)

**Die**  
(41983-05)



**StuffMaster Portioner**  
(0920)



# MPBS INDUSTRIES BUTCHER SUPPLIES 2



**Grinder Accessories Tool Rack**  
(41599-ORACK)

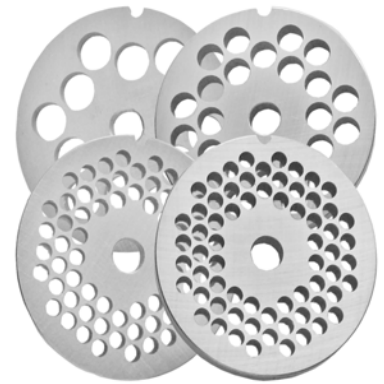

**Grinder Plates**

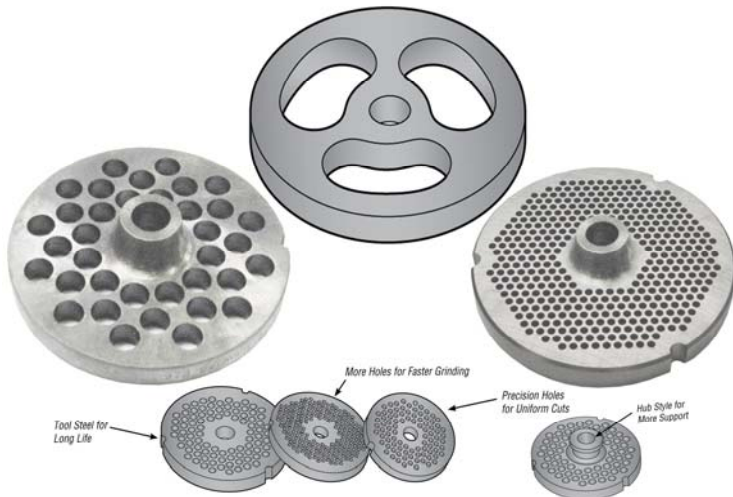

**Grinder Knives**



**Grinder Safety Stomper**



**Grinder Head Fiber Washer**



**323-268-8514** ◆ **800-421-6265** ◆ **www.mpbsonline.com**



**Bone Dust Removers**  
(70252-70253)



**Scraper: Block**  
(70611)



**Shears** (70451-4329G - 70451-4328N)



**Handsaw** (70382, 70383, 70387, 70390)



**Stainless Steel  
Scaler Steel**  
(70588)



**Bell Hog Scraper**  
(70553)



**Casing Perforator**  
(70557)



**Tenderizer**



**Beef Tier**  
(70392)

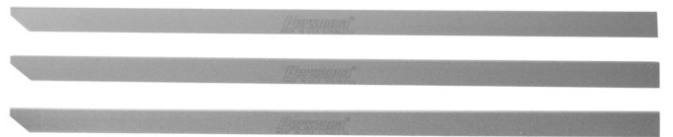

**Skinner Blades**  
(41951-S-6070)



**Fat Analyzer**  
(42054)



**Aluminum Scoop**  
(70561-70565)



**Stainless Steel Scoop**  
(70542, 70545)



**Plastic Scoop**  
(70602)



## Bandsaw Blades List

Item #	TPI	Thickness	Band Length
41700-065	3	.020"	065"
41700-066	3	.022"	066"
41700-066/SC	3	.022"	066"
41816	4	.025"	072"
41817	4	.020"	078"
41820	3	.020"	078"
41700-086/SC	2	.022"	086"
41701	4	.022"	091"
41701-02	3	.022"	091"
41700-094	3	.020"	094"
41709	4	.022"	098"
41717	4	.022"	106"
41719	4	.020"	108"
41719-02	3	.022"	108"
41724	3	.025"	112"
41725	4	.025"	112"
41732	3	.025"	116"
41733	4	.025"	116"
41731-SC	2	.022"	116"
41740	3	.025"	118"
41741	4	.025"	118"
41742	3	.022"	120"
41743	4	.022"	120"
41748	3	.025"	124"
41749	4	.025"	124"
41749-SC	2	.022"	124"
41757	4	.025"	125.5"
41764	2	.022"	126"
41770	4	.020"	126"
41771	3	.020"	126"
41818	4	.025"	126"
41821	3	.025"	126"
41764-LPS20	2	.020"	126"
41771-014	3	.014"	126"
41818-LPS22	4	.022"	126"
41772	3	.025"	128"
41773	4	.025"	128"
41780	3	.025"	135"
41781	4	.025"	135"
41784	3	.025"	142"
41785	4	.025"	142"
41788	3	.025"	154"
41789	4	.025"	154"
41799	3	.032"	216"
41802	3	.032"	248"
41708	3	.022"	98"

## Bandsaw Blades Reference Guide

Make	Model	Band Length
Biro	11	91"
Biro	22SS	91"
Biro	22SSHD	91"
Biro	1433	108"
Biro	1433FH	108"
Biro	5614	112"
Biro	5514	112"
Biro	33	116"
Biro	34	118"
Biro	3334SS	124"
Biro	3334SS-4003	124"
Biro	3334SS-4003FH	124"
Biro	3336	124"
Biro	44	135"
Biro	44SS	135"
Biro	4436-DS	* 166"
Biro	4436-DSE3	* 166"
Biro	4436-DI3B	178"
Biro	4436-14B-TL	178"
Biro	55	164.5"
Butcher Boy	B-12	98"
Butcher Boy	SA-12	98"
Butcher Boy	B-14	112"
Butcher Boy	SA-14	112"
Butcher Boy	1435	112"
Butcher Boy	Easy Speed	118"
Butcher Boy	Senior	118"
Butcher Boy	B-16	126"
Butcher Boy	SA-16	126"
Butcher Boy	SA-20	154"
Butcher Boy	SA-30	* 216"
Butcher Boy	SA-36	* 254"
Torrey	ST-200-AL	79"
Torrey	ST-200-PE	79"
Torrey	ST-295	116"
Torrey	ST-305 SH	120"
Pro-Saw	SS-16 E	126"
Pro-Saw	SS-16 HD	126"
Pro-Saw	SS-16 HS	126"
Pro-Saw	SS-20 HD	154"
German Knife	GBS-230A	* 66"
German Knife	GBS-270S	* 92.9"



Equipment for Industrial Food Processing & Packaging

2820 East Washington Blvd. Los Angeles CA 90023  
323-268-8514 800-421-6265 323-268-6305 (fax)

www.mpbs.com

\* Available by special order.



Bandsaw	
Height	Thickness
5/8"	0.014"
5/8"	* 0.016"
5/8"	* 0.018"
5/8"	0.020"
5/8"	0.022"
5/8"	0.025"
1"	0.032"

**Blade Profile**  
4 Teeth Per Inch

**Blade Specifications:**  
Height - 5/8"  
Thickness - .022"  
4 Teeth per inch



**Blade Profile**  
3 Teeth Per Inch

**Blade Specifications:**  
Height - 5/8"  
Thickness - .022"  
3 Teeth per inch

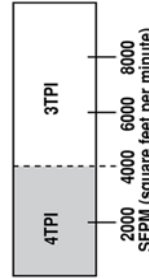

**Note:**

- If blade speed is less than 4000 sfpm 4 TPI band is recommended
- If blade speed is greater than 4000 sfpm 3 TPI band is recommended
- Other sizes available by special order



**Cut Resistant Whizzard Heavy-Duty Glove**  
(69620, 69621, 69622, 69623)

**Butchers' Gloves**



**Black Dot 2 Sided Nylon Glove**  
(61080)



**Poly/Cotton Blend Glove**  
(61008-SM, 61007, 61008)



**Polar Bear Plus Cut Resistant Gloves**  
(69627)



**Cut Resistant Safe Knit, Light Duty Glove**  
(69611 - 69613)



**Cut Resistant Medium Duty Glove**  
(69626)



**Orange Nylon Glove**  
(61085)



**Atlas Fit Coated Work Gloves**

**Food Handling Gloves**



**Food Prep Disposable Glove**  
(61033)



**Disposable Powder Free Glove**  
(61034-MD, 61034-LR)



**Blue Nitrile Powder Free Glove**  
(61001-PFL)



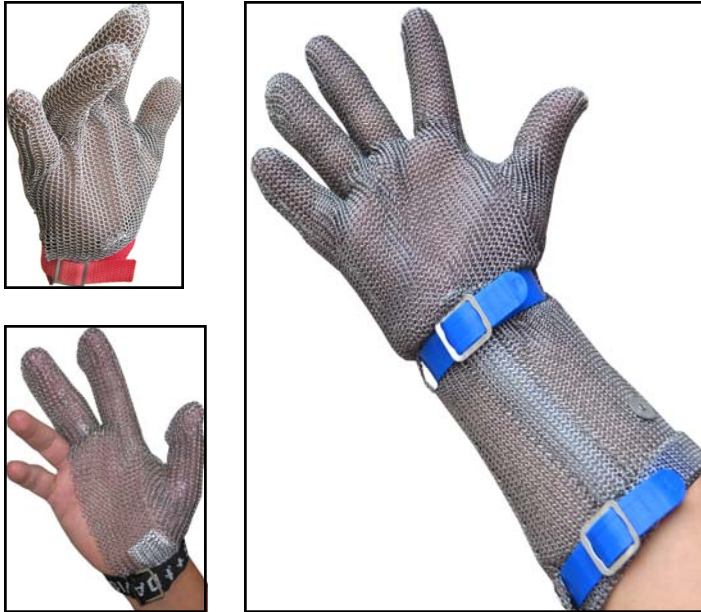

**Metal Mesh Glove**



**Natural Latex Reusable Glove**  
(61012-XS, 61012 - 61014)

**Green Nitrile**  
(61009, 61010, 61011)



**Bump Cap**  
(69080, 69081, 69082, 69083, 69084, 69085)



**Arm Guard**  
(69039-01, 69039-02, 69039-11, 69039-12, 69038, 69038-02)





**Black Heavy Duty Apron (61017)**  
**Yellow Heavy Duty w/ Belly Patch (61018)**  
**White Medium Duty (61019)**



**Green PVC w/ Protective Belly Patch Apron (61023)**



**Disposable White Apron (61026)**  
**Hair Net (100) per box (61210-408)**  
**Beard Guard (100) per box (61220-410)**



**Butcher Frock Buttons (60004-MDB, 60004-LRB, 60004-XLB)**  
**Butcher Frock Snaps (60004-MDS, 60004-LRS, 60004-XLS)**



**Butcher Frock Wrap Around (60006-MD, 60006-LR, 60006-XL)**



**Blue Vinyl Apron (61036)**



**White PVC Vinyl Wash Up Apron (61035)**







**Refrigiwear Coat**  
Cooler Frock Coat 34  
Comfort Rating: 0°

Knee length; Side seam openings for access to pants pockets; Clipboard-sized pockets; Insulated knit collar; Snap closure; Fits under frocks or lab coats.

Stock #	Size - Color
1. 60035	Small - Blue
2. 60036	Medium - Blue
3. 60037	Large - Blue
4. 60038	X Large - Blue
5. 60038-2XB	XX Large - Blue
6. 60038-3XB	3X Large - Blue
7. 60038-4XB	4X Large - Blue



**Refrigiwear Vest**  
Cooler Vest 12

Comfort Rating: 0°  
Thermal stretch knit side gussets for snug fit; Insulated hand warmer pockets; Insulated knit collar; Extra long back for warmth.

Stock #	Size - Color
1. 60027	Small - Blue
2. 60028	Medium - Blue
3. 60029	Large - Blue
4. 60030	X Large - Blue
5. 60031	XX Large - Blue



**Refrigiwear Jacket**

Cooler Jacket 525  
Comfort Rating: 0°

Hip-Length; Insulated hand warmer pockets; Insulated knit collar; Storm flap over zipper.

Stock #	Size - Color
1. 60023-XSB	X Small - Blue
2. 60023	Small - Blue
3. 60024	Medium - Blue
4. 60025	Large - Blue
5. 60026	X Large - Blue
6. 60022	XX Large - Blue
7. 60021	3X Large - Blue



**Refrigiwear**  
Denim High Bib Overall 685  
Comfort Rating: 0°

Hip-length two-way leg zippers; Adjustable heavy-duty 2" elastic suspenders and inside waist draw cord; It also has chest and hand warmer pockets; Back pocket; Tool loop.

Stock #	Size - Color
1. 60139-LBK	Large - Black



**Refrigiwear Jacket**  
Econo Tuff Jacket 925  
Comfort Rating: 15°

Insulated hand warmer pockets; Insulated knit collar; Heavy-duty knit cuffs; 6 oz mid-loft insulation; Durable 200 denier polyester outer shell; Bound seams seal out drafts.

Stock #	Size - Color
1. 60158-2X	XX Large - Navy



**Refrigiwear**  
Cooler Trousers 526  
Comfort Rating: 0°

7.5 oz mid-loft insulation; Water-repellent, rip-stop nylon outershell; Bound seams to seal out drafts and extend durability; Heavy-duty knit cuffs.

Stock #	Size - Color
1. 60160	Small - Blue
2. 60161	Medium - Blue
3. 60162	Large - Blue
4. 60163-1XB	X Large - Navy
5. 60163-2XB	XX Large - Blue
6. 60163-3XB	3X Large - Blue





### Refrigiwear

#### Comfortguard Coverall 640

Comfort Rating: 0°

7.5 oz mid-loft insulation; Rugged 100% cotton denim outershell; Rust-proof hardware; Weather-resistant, water-repellent finish; Hip-length two-way leg zippers; Heavy-duty knit cuffs; Inside waist draw cord; Front and back pockets; Pencil pocket on the sleeve and a tool loop.

**Stock #**

**Size - Color**

- |    |           |               |
|----|-----------|---------------|
| 1. | 60138-LBK | Large - Black |
|----|-----------|---------------|



### Refrigiwear

#### Freezer Iron Tuff

#### High Bib Overall 385

Comfort Rating: -50°

High front and back; Adjustable Heavy-Duty 2" elastic suspenders; Insulated Pockets: Two in front and one in back.

**Stock #**

**Size - Color**

- |    |            |                      |
|----|------------|----------------------|
| 1. | 60140-SN   | Small - Navy         |
| 2. | 60140-LN   | Large - Navy         |
| 3. | 60140-1XN  | X Large - Navy       |
| 4. | 60140-2XN  | XX Large - Navy      |
| 5. | 60140-3XN  | 3X Large - Navy      |
| 6. | 60140-3XNT | 3X Large Tall - Navy |



### Refrigiwear Coat

#### Freezer Iron Tuff

#### Inspector Coat 341

Comfort Rating: -50°

Knee length coat with adjustable belt; Nylon collar; Clipboard-sized insulated patch pockets; Side seam opening for trouser pocket access.

**Stock #**

**Size - Color**

- |    |           |                 |
|----|-----------|-----------------|
| 1. | 60060     | Small - Navy    |
| 2. | 60061     | Medium - Navy   |
| 3. | 60062     | Large - Navy    |
| 4. | 60063     | X Large - Navy  |
| 5. | 60063-2XB | XX Large - Navy |
| 6. | 60063-3XB | 3X Large - Navy |





**Refrigiwear**  
Freezer Chill Breaker  
High Bib 485

Comfort Rating: -10°

7.5 oz insulation; High front and back; Hip-length, two-way zippers; Adjustable 2" elastic suspenders; Interior waist draw cord; Front and back pockets; Tool loop.

Stock #	Size - Color
1. 60141-1XN	X Large - Navy
2. 60141-2XN	XX Large - Navy



**Refrigiwear Jacket**  
Freezer Chill Breaker Jacket 450

Comfort Rating: -20°

Versatile all-season jacket; Water-Repellent microfiber outershell; 5.5 oz insulation; Knit waist band; Insulated zippered hand warmer pockets; Interior essentials pocket; Full-zip fleece collar; Extra long Heavy-Duty knit cuffs.

Stock #	Size - Color
1. 60150-3XBT	3X Large - Navy



**Refrigiwear**  
Freezer Iron Tuff  
Tanker Jackets 356

Comfort Rating: -50°

Waist length with knit waist band; Large insulated hand warmer pockets; Bulk knit nylon cuffs and cozy fleece collar; Thermometer pocket on sleeve.

Stock #	Size - Color
1. 60152-LN	Large - Navy
2. 60152-1XN	X Large - Navy
3. 60152-2XN	XX Large - Navy



**Refrigiwear**  
Freezer Iron Tuff  
Polar Jacket 322

Comfort Rating: -50°

Hip length; Insulated patch pockets; Snaps for 40Q Iron Tuff Hood.

Stock #	Size - Color
1. 60145-MN	Medium - Navy
2. 60145-LN	Large - Navy
3. 60145-1XN	X Large - Navy
4. 60145-2XN	XX Large - Navy
5. 60145-3XN	3X Large - Navy
6. 60145-T3XN	3X Large Tall - Navy



**Refrigiwear Vest**  
Freezer Iron Tuff Vest 15

Comfort Rating: -50°

Knit side gussets for snug fit; Longer back provides extra warmth; Insulated knit collar; Hand warmer pockets.

Stock #	Size - Color
1. 60027-15XSN	X Small - Navy
2. 60027-15SN	Small - Navy
3. 60028-15MN	Medium - Navy
4. 60029-15LN	Large - Navy
5. 60030-15XLN	X Large - Navy
6. 60031-152XN	XX Large - Navy
7. 60031-153XN	3X Large - Navy
8. 60031-154XN	4X Large - Navy
9. 60031-155XN	5X Large - Navy





### Refrigiwear Jacket

Freezer Iron Tuff

Siberian Jacket 358

Comfort Rating: -50°

Fingertip length; Athletic cut sleeves; Insulated patch and breast pockets; Snaps for 40Q Iron Tuff Hood.

	Stock #	Size - Color
1.	60154-MN	Medium - Navy
2.	60154-LN	Large - Navy
3.	60154-1XN	X Large - Navy
4.	60154-2XN	XX Large - Navy
5.	60154-2XNT	XX Large Tall - Navy



### Refrigiwear Parka

Freezer Iron Tuff

Ice Parka 60S

Comfort Rating: -50°

Sewn-On hood with knit wind seal; Thigh length; Athletic cut sleeves; Large insulated hip and breast pockets; Thermometer pocket on sleeve; Draft-sealing elastic back band; Bulk knit Heavy-Duty nylon cuffs.

	Stock #	Size - Color
1.	60039-MED	Medium - Green
2.	60039-01G	Large - Green
3.	60039-01N	Large - Navy
4.	60039-1XN	X Large - Navy
5.	60039-1XG	X Large - Green
6.	60039-2XG	XX Large - Green
7.	60039-2XN	XX Large - Navy



### Refrigiwear Jackoat

Freezer Iron Tuff Jackoat 342

Comfort Rating: -50°

Fingertip length; Two way zipper; Clipboard sized insulated pockets; Snaps for 40Q Iron Tuff Hood.

	Stock #	Size - Color
1.	60064-XSG	X Small - Green
2.	60064-XSN	X Small - Navy
3.	60064	Small - Green
4.	60064-02	Small - Navy
5.	60065	Medium - Green
6.	60065-02	Medium - Navy
7.	60066	Large - Green
8.	60066-02	Large - Navy
9.	60067	X Large - Green
10.	60067-02	X Large - Navy
11.	60067-2XG	XX Large - Green
12.	60067-2XN	XX Large - Navy
13.	60067-3XG	3X Large - Green
14.	60067-3XN	3X Large - Navy
15.	60067-3XNT	3X Large Tall - Navy
16.	60067-4XG	4X Large - Green
17.	60067-4XN	4X Large - Navy





### Refrigiwear Coverall

Freezer Iron Tuff

Coverall w/ Hood Suit 541

Comfort Rating: -50°

Sewn-On hood with knit wind seal; Full body coverage; Insulated oversize pockets; Bulk knit Heavy-Duty nylon cuffs.

Stock #	Size - Color
1. 60072	Small - Green
2. 60073	Medium - Green
3. 60073-02	Medium - Navy
4. 60074	Large - Green
5. 60074-02	Large - Navy
6. 60075	X Large - Green
7. 60075-02	X Large - Navy
8. 60075-2XG	XX Large - Green
9. 60075-2XN	XX Large - Navy
10. 60075-3XG	3X Large - Green
11. 60075-4XG	4X Large - Green
12. 60075-5XG	5X Large - Green



### Refrigiwear Overall

Freezer Iron Tuff

Low Bib Overall 345

Comfort Rating: -50°

Low front and high back; Adjustable Heavy-Duty 2" elastic suspenders; Insulated pockets: Two in front and one in back.

Stock #	Size - Color
1. 60068	Small - Green
2. 60068-02	Small - Navy
3. 60069	Medium - Green
4. 60069-02	Medium - Navy
5. 60070	Large - Green
6. 60070-02	Large - Navy
7. 60071	X Large - Green
8. 60071-02	X Large - Navy
9. 60071-2XG	XX Large - Green
10. 60071-2XN	XX Large - Navy
11. 60071-3XG	3X Large - Green
12. 60071-3XN	3X Large - Navy
13. 60071-4XG	4X Large - Green
14. 60071-4XN	4X Large - Navy



### Refrigiwear Coverall

Freezer Iron Tuff

Coverall without Hood Suit 544

Comfort Rating: -50°

Full body coverage; Insulated oversize pockets; Bulk knit Heavy-Duty nylon cuffs; Cozy fleece collar.

Stock #	Size - Color
1. 60148-LN	Large - Navy
2. 60148-1XN	X Large - Navy
3. 60148-2XN	XX Large - Navy





**Refrigiwear Gloves**  
Freezer Gloves 20GL  
Goatskin

Stock #	Size
1. 60079-03	Large



**Refrigiwear Gloves**  
Freezer Gloves 320  
Extreme Grip Pigskin  
Comfort Rating: -25°

Grip reinforcement on palm, fingers and thumb; Pigskin offer excellent abrasion resistance; Foam and fiberfill insulation; Soft fleeced lining.

Stock #	Size
1. 60090-320-L	Large
2. 60090-320-XL	X Large



**Refrigiwear Gloves**  
Freezer Gloves 20P  
Deerskin

Comfort Rating: -20°  
Great dexterity in sub-zero cold; Foam and fleece insulation; Soft fleeced lining.

Stock #	Size
1. 60079	Large



**Refrigiwear Gloves**  
Freezer Gloves 20PD  
Waterproof Palm Dipped Deerskin

Comfort Rating: -20°  
Dipped in latex; Supple deerskin offers dexterity; Foam and fleece insulation; Soft fleeced lining.

Stock #	Size
1. 60079-02	Large



**Refrigiwear Gloves**  
Freezer Gloves 20HD  
Waterproof Cowhide  
Comfort Rating: -20°

Thinsulate and foam insulation; Rugged split cowhide; Reinforced palm and thumb; Soft fleeced lining.

Stock #	Size
1. 60100	Large
2. 60100-02	X Large



**Refrigiwear Gloves**  
Freezer Gloves 222  
Double Insulated Cowhide  
Comfort Rating: -30°

Premium split cowhide; Double foam and double fleece insulation; Reinforced palm and thumb.

Stock #	Size
1. 60090-222-L	Large
2. 60090-222-XL	X Large





**Refrigiwear Gloves**  
Insulated Brown Jersey Gloves  
306

100% Cotton knit; Foam insulation; Brushed tricot lining; Clute cut with knit wrist.

Stock #	Size
1. 60090-306-L	Large



**Refrigiwear Gloves**  
Chillbreaker Gloves 318  
Comfort Rating -20°

Fabric glove which is light-weight and flexible; Full sock lining of foam and fleece; Vinyl grip reinforcements; Reflective tape on front side.

Stock #	Size
1. 60090-318-L	Large
2. 60090-318-XL	X Large



**Refrigiwear Gloves**  
284 ProSeries High Dexterity  
Comfort Rating: -10°

Waterproof breathable barrier; PVC, neoprene, and spandex outer shell; Wicking fleece lining; Traction thumb crotch and index finger; Padded impact protection on palm; Microfiber brow wipe; Neoprene cuff with rubber Velcro closure.

Stock #	Size
1. 60090-284-M	Medium
2. 60090-284-L	Large
3. 60090-284-XL	X Large



**Refrigiwear Gloves**  
Insulated High Dexterity Gloves  
283

Comfort Rating: -20°  
Fleece and fiberfill insulation; Spandex, neoprene and PVC outershell; Hydroguard waterproof barrier; Wicking polypropylene lining; Goat skin palm; Gauntlet style with inner heavy duty knit cuff.

Stock #	Size
1. 60090-283-M	Medium
2. 60090-283-L	Large
3. 60090-283-XL	X Large



**Refrigiwear Gloves**  
Dipped Waterproof Gloves  
28WP

Comfort Rating: 10°  
Foam and fleece insulated; Ergonomically designed for fit; Knit wrist for snug fit.

Stock #	Size
1. 60090-28WP	Large



**Refrigiwear Mitt**  
Convertible Mitt 304  
Comfort Rating: 10°

Thinsulate with tricot lining; 100% rag wool outershell; Leather palm; Converts from mitten to open-finger glove; Velcro tie-back.

Stock #	Size
1. 60090-304-L	Large





**Refrigiwear Gloves**  
**Thermax Liner Gloves 225**

Superb fit; Thermax hollow-core fibers prevents heat loss; Wicking action removes moisture away from skin; Sold by the dozen.

**Stock #                      Size**

- 1. 60090-LT-25-MD Medium
- 2. 60090-LT-25-LR Large



**Refrigiwear Gloves**  
**Polypropylene Liner Gloves 223**

Moisture wicking; 100% stretch polypropylene; Knit outershell slides easily into gloves; Sold by the dozen.

**Stock #                      Size**

- 1. 60090-LP-23-MD Medium
- 2. 60090-LP-23-LR Large



**Refrigiwear Gloves**  
**Wool Liner Gloves 221**

Military issue; 70% green rag wool and 30% nylon; Pre-laundered for softness; Sold by the dozen.

**Stock #                      Size**

- 1. 60090-LW-21-LXL X Large



**Refrigiwear Hot Hands**  
**HH2 Hot Hands**

All natural; Easy to use, self-activating; Up to 10 hours of safe, comfortable warmth; Average temperature 126-144°F

**Stock #                      Quantity**

- 1. 60090-HH2 40 Packs Per Case



**Refrigiwear Sock**  
**Wick Sock 33**

Extra protection, increase comfort; Extra thick acrylic, nylon and cotton absorbs moisture and transfers it away from skin.

**Stock #                      Size**

- 1. 60114 Medium
- 2. 60115 Large



**Refrigiwear Headband**  
**Fleece Headband 53**

Double thick fleece with an enlarged area to cover ears; Color: Black; One size.

**Stock #                      Size**

- 1. 60111-93 One size







**Refrigiwear Mask**  
**Fleece Lined Mask 55**

Double layer acrylic lining for warmth; Long neck for

Stock #	Color
1. 60113-55	Black



**Refrigiwear Mask**  
**Face Protector 10**

Light weight waffle knit; Conforms easily to head.

Stock #	Color
1. 60113	Brown



**Refrigiwear Mask**  
**Three Hole Mask 51**

Double layer acrylic knit.

Stock #	Color
1. 60113-51	Black



**Refrigiwear Mask**  
**Thermal Knit Mask 42**

Stock #	Color
1. 60113-42N	Navy



**Refrigiwear Mask**  
**Open Hole Mask 47**

Double layer acrylic

Stock #	Color
1. 60113-47N	Navy



**Refrigiwear Cap**  
**Watch Cap 45**

Wool/Acrylic outer layer for warmth; Polypropylene inner lining for wicking action.

Stock #	Color
1. 60112-45	Black



**Refrigiwear Hood**  
**Iron Tuff Hood 40Q**

Knit wind seal around face; Self-locking draw-string.

Stock #	Color
1. 60076	Sage
2. 60077	Navy



**Refrigiwear Mask**  
**Neofleece Combo Clava 92**

4-way stretch outer shell; 200 wt Polartec fleece lining; Neofleece moisture wicking facemask; Breathable waterproof, windproof membrane; Mouthpiece with breathing holes; Wear as balaclava, open hole mask or gaiter.

Stock #	Color
1. 60113-92-SM	Small
2. 60113-92-LX	X Large



**Refrigiwear Neck Gaitor**  
**Knit Neck Gaitor 50**

Covers nose, mouth, ears, and neck; Double layer acrylic knit.

Stock #	Color
1. 60113-50	Black



**Footwear**



**PVC Steel Toe**  
(69638-69645)



**White PVC Steel Toe 16"**



**Neo Plain Toe**  
(69508-69515)



**PVC Plain Toe**  
(69630-69637)



**White PVC Steel Toe 14"**



**Neo Steel Toe**  
(69524-69531)



**Servus Pro Hi Boot**



**Pro-Safety Gray High Boot**  
(69692-07 - 69692-12)



**Insulated Wolf Pac**  
(69680-69684)



## Forschner® Victorinox Fibrox Collection



70264



70263, 70265



70269, 70270



70256-40508



70256-40505



70272



70277, 70278-10, 70278-12



70257-20



70300-02



70266, 70267, 70268



70273, 70274



70275, 70276



70260, 70261



70257, 70257-10



70256-40547



70258-10, 70256-40522



70256-40640



## Forschner® Victorinox Rosewood



70153, 70154, 70155



70160

## Torrey Slicer Knives



Torrey Slicer Knives (70102, 70110, 70104, 70106, 70108)

## Dexter Russell



(70244)



# MPBS INDUSTRIES CUTLERY & ACCESSORIES 1



Cleaver (70301, 70302, 70303)



Ring Knife



Magnetic Knife Rack 18"  
(70281)



Heating Element (Box w/ Heater) (30028)  
Sterilizer Box (30027)  
Replacement Heater (30030)



Sausage Sampling Knife



Oyster Knife  
(70283)

323-268-8514 ♦ 800-421-6265 ♦ [www.mpbsonline.com](http://www.mpbsonline.com)



# MPBS INDUSTRIES CUTLERY & ACCESSORIES 2



Waist Chain Knife Holster



Knife Support



Aluminum Knife Holster

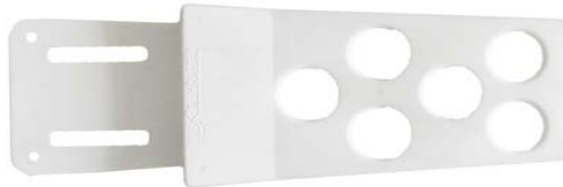

Plastic Knife Holster



556 Cleaver and Saw Sterilizers



Cutting Board  
(10230, 10231, 10232)



Dassaud Fils X-1®  
Crossed Steel Sharpener  
(70420-X1)





Sharpening Steel (70321)



Sharpening Steel (70341)



Sharpening Steel (70426)



Sharpening Steel (70349)



Sharpening Steel (70346, 70347)



Sharpening Steel (70423)



Sharpening Steel (70351)



Sharpening Steel (70350)



Sharpener (70016)



Multi Oilstone Unit Sharpener  
(70010)  
Replacement Stone  
(70011, 70012, 70013)



Sharpener  
(70085)



F. Dick Rapid Steel Hyper  
Drill Sharpener and Stand  
70420-RSST - 70420-RSHD



Jumbo Combination Stone  
(70020)



Combination India  
Stone (70031, 70033,



Sharpening Oil  
1 Quart: 70015





**Boot Dip Disinfectant**  
(80047)



**Chlorine Test Paper**  
(81070)



**Boot Dip Mat High Sidewalls**  
(80044)

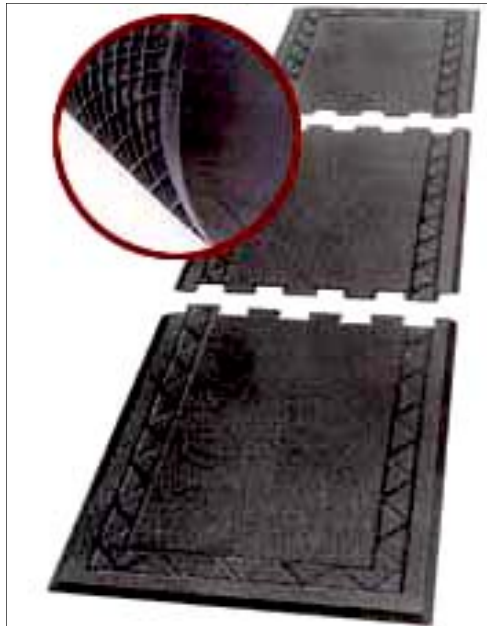

**Comfort Grease Resistant Floor Mats**  
Single: 80035  
Middle: 80037  
End: 80036



**Boot Dip Mat No Sidewalls**  
(80046)





# Hoses & Nozzles



**Washdown: Hose Yellow**  
(81007, 81007-02, 81007-03)



**Washdown: Hose White**  
(81002, 81003, 81003-75)



**Washdown: Hose Red**  
(81004, 81005, 81005-075,  
81005-100)



**Washdown: Replacement Cover**  
(81015)



**Washdown: Tricon Nozzle**  
(81016)



**Washdown: Spray Nozzle**  
(81013)



**Washdown: Replacement  
Hose Adaptor**  
(81013-GHTS)



**Washdown: Replacement Cartridge**  
(81014)





**FD & C Red Concentrate Denaturant**  
(81168)



**Denaturant G**  
(81169)



**Liquik Char**  
(81167)



**Branding Ink**  
Purple: 81220  
Red: 81225





**White Mineral Oil**  
55 Gallon Drum: (81060)  
5 Gallon: (81061)  
1 Gallon: (81061-1G)



**LPS Heavy-Duty  
Silicone Lubricant  
Spray**  
(80143-12)



**Lubricate Super FML-2 Grease  
Spray Can: (80143-11)  
Cartridge: (80143)**

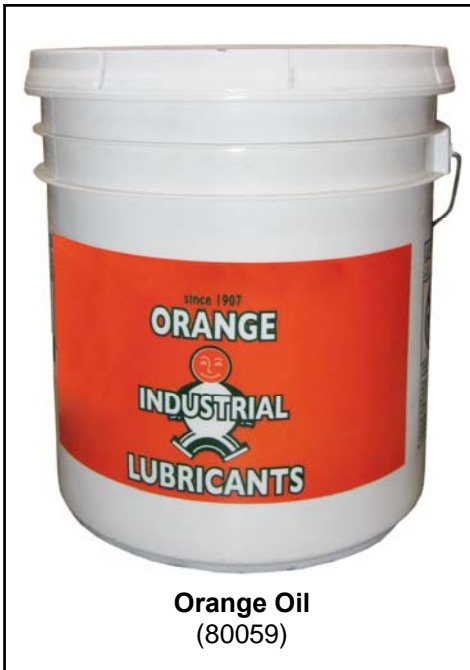

**Orange Oil**  
(80059)



**Grease Gun**  
(80143-50)



**Huskey Lube O  
Seal LVI-50  
Grease Cartridge**  
(80143-02)





**Pail**  
(81049, 81050, 81051)



**Chicken Drip: Pan** (21345)



**Chicken Drip: Dolly**  
(21348)



**Meat Lug Lids**  
(21335, 21336)



**Jumbo Meat Lugs**  
(21313)



**Meat Lugs**  
(21330, 21331, 21333, 21334, 21337, 21338, 21339)





**Receptacles Drums**

(21029-BLU, 21029-GRN, 21021-ORN, 21025-ORN, 21003, 21021, 21025, 21029, 21019, 21025-RED, 21029-RED, 21001, 21020, 21024, 21028, 21021-YEL, 21025-YEL)

**Receptacles Drum Lids**

(21002, 21031, 21031-BLU, 21004, 21011, 21023, 21026, 21027, 21030, 21031-GRN, 21031-RED)



**Universal Drum Dolly**  
(21039-2650)



**Twist-On Drum Dolly**  
(21039)

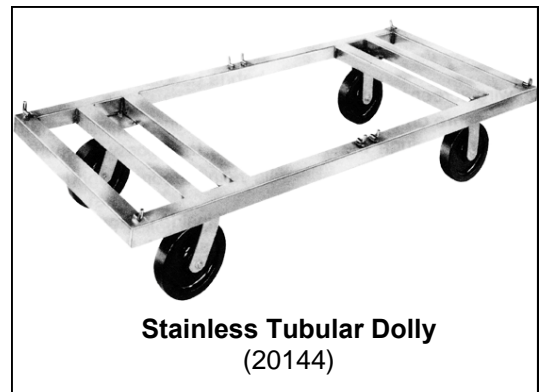

**Stainless Tubular Dolly**  
(20144)



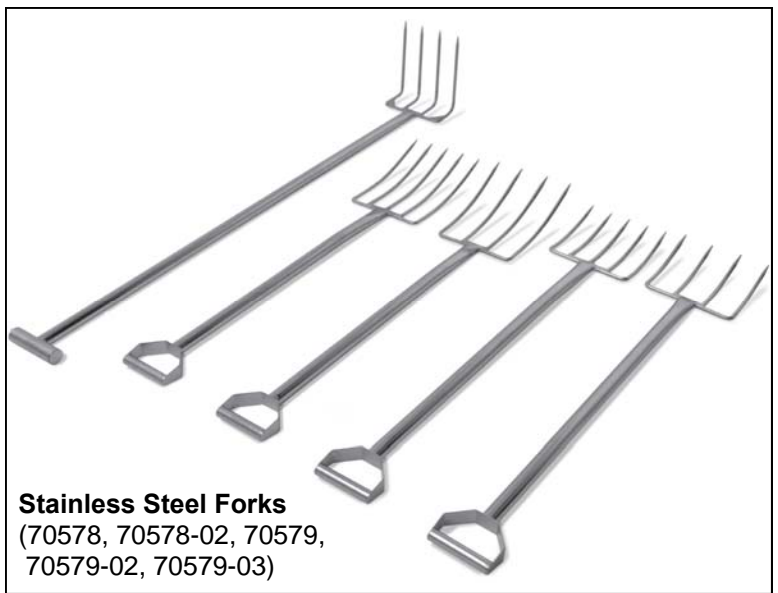

## Stainless Steel Trucks



## Stainless Steel Buggies



**Buggy lid (12015-SS-LID)**



**MPBS Buggy Lid (12015-LID)**



**Buggies (12015, 12016)**



**Buggies (12017-CBS)**







**Heavy Duty Aluminum  
Platter Carts**  
(21533-02, 21533)



**Lug: Dolly 6 Tier**  
(21505, 21520)



**Aluminum Platter Cart**  
(21532)  
**Stainless Steel Platter  
Cart** (21519)



**Lug: Dolly 1 Tier**  
(21500)



**Lug: Dolly 2 Tier**  
(21502)



**Lug: Dolly 2 Tier w/  
Handle**  
(21503)



**Lug: Dolly 1 Tier w/  
Handle**  
(21501)





**Stainless Steel Flatform Truck**  
(2080)



**Stainless Steel Double Tote Dolly**  
(2079)



**Stainless Steel Equipment Stand with Handle**  
(2081)



**Stainless Steel Single Tote Dolly**  
(2078)



Mobile Work Table, Boot Rack, Hog Cage, & Tank



Boot Rack



Hog Cage



Stainless Steel Tank



Poultry Mobile Table





Micro Layered Bags



Safe Handling Pouches



Gold Metallic Pouches



Waxed Bone-Guard



Zipper Pouch  
available w/ tear  
notch, hang holes



Standard / Boilable:  
3, 4, 5, 6 Mil Thickness  
Poly/Nylon 7 Layers



Twine



Foil Boards



Beef Tubing



Ham Tubing



Polypropylene Straps





USED WITH THE FOLLOWING NETTING SIZES		
3-Stitch Cotton Netting	14 Square	3.5" Working diameter
	16 Square	4.0" Working diameter
	18 Square	4.5" Working diameter
5-Stitch Cotton Netting	10 Square	3.0" Working diameter
	14 Square	4.0" Working diameter
	18 Square	5.0" Working diameter

**CHM**



USED WITH THE FOLLOWING NETTING SIZES		
3-Stitch Cotton Netting	16 Square	4.0" Working diameter
	18 Square	4.5" Working diameter
5-Stitch Cotton Netting	16 Square	4.5" Working diameter
	18 Square	5.0" Working diameter
	22 Square	6.0" Working diameter

**CHL**



USED WITH THE FOLLOWING NETTING SIZES		
3-Stitch Cotton Netting	18 Square	4.5" Working diameter
	22 Square	5.5" Working diameter
	24 Square	6.5" Working diameter
5-Stitch Cotton Netting	18 Square	5.0" Working diameter
	22 Square	6.0" Working diameter
	26 Square	7.5" Working diameter

**CXHL**



USED WITH THE FOLLOWING NETTING SIZES		
3-Stitch Cotton Netting	24 Square	6.5" Working diameter
5-Stitch Cotton Netting	22 Square	6.0" Working diameter
	26 Square	7.5" Working diameter



**JetNet Nettings**



# Retail Display



**Aluminum Platter:**  
(21630, 21636, 21642, 21646, 21647)



**Aluminum Pan:** (21605, 21611, 21618)



**Plastic Pan:** (21662, 21663, 21664)



**Platter Sheets**



**Fiberglass Platters:** (21653, 21654, 21654-12)

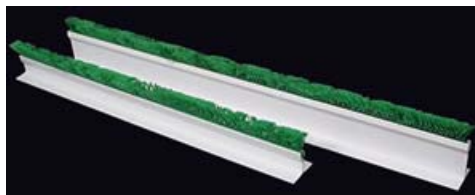

**Parsley Divider Holder** (81351)  
**Parsley Divider Green** (81362)  
**Parsley Divider Red** (81362-RD)



**Price Cards:** (70795, 70796)



**Perforated Bottom Aluminum Platters**



**Plastic White Pin Tag - 20:** (70801)  
**Red Assorted 1 1/2" High # Set - 100:** (70802)  
**Red # 9 & 6 only - 25:** (70803)





**Over / Under Check  
Weigher 90**  
(40378-50)



**EQB 20/40 Waterproof  
Bench Scale**  
(40361)



**EQB 50/100  
Bench Scale**  
(40361)



**EQB 50/100  
Waterproof Bench Scale**  
(40360)



**SR-50/100  
Bench Scale**  
(40365)



**LEQ Portioning Scale**  
(40305-10, 40305-20)



**L-PC-40L Price  
Computing Scale**  
(40277)



**S-199 Scale**  
(40291)



**Scale (40276)**



**Impulse Sealer**



**Sealing Iron (81338)**

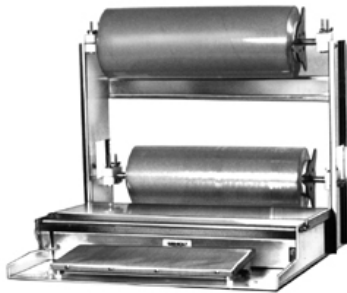

**Two Roll Wrapper  
(81321)**



**Impulse Sealer w/ Cutter**



**Three Roll Wrapper  
(81337)**



**TW-500-E Wrapper (1 roll)  
(81318)**



**Wrapper (1 roll)  
(81320)**





# MPBS Slaughter Equipment & Accessories

INDUSTRIES



**Jarvis 16" Wellsaw 404**  
(41081)



**Jarvis 16" Wellsaw 444**  
(41083)



**Jarvis Wellsaw Blade Support**  
(41132, 41158, 41132-HD, 41154-HD, 41150-HD)



**Jarvis Wellsaw Saw Blades**  
(41155-HD, 41148, 41149, 41149-HD, 41156-HD)



**Trolley Hook**



**Boning Hook**

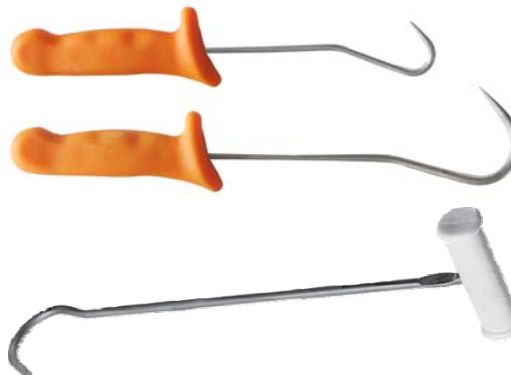

**Wellsaw 444 Balancer**  
(41083-BAL)



## Smokescreens

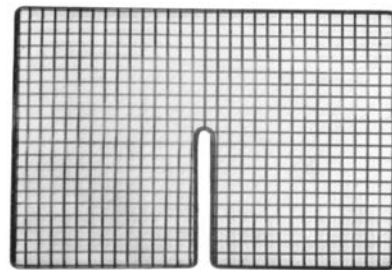
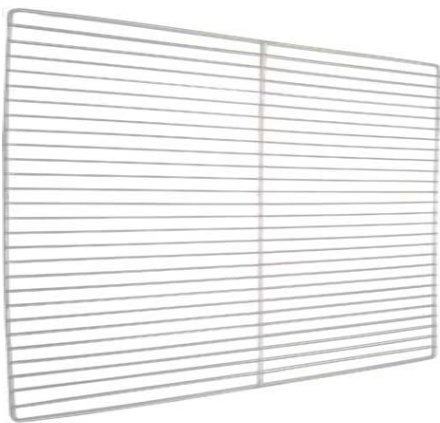
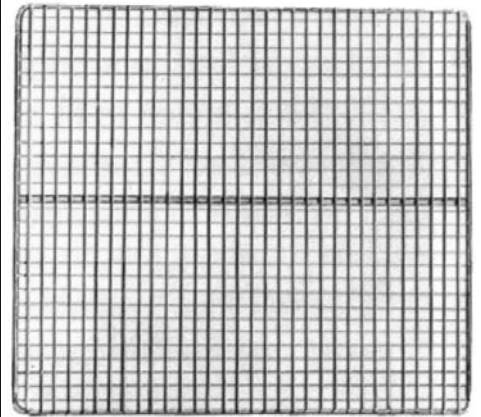
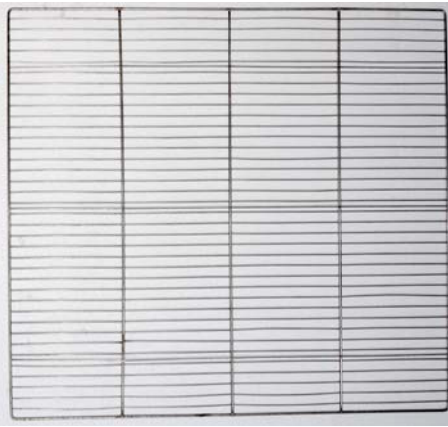

Smokehouse Screen Net



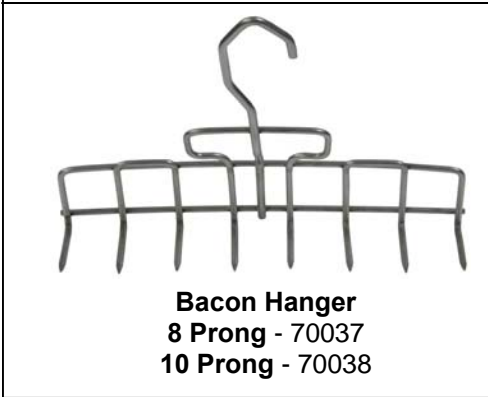
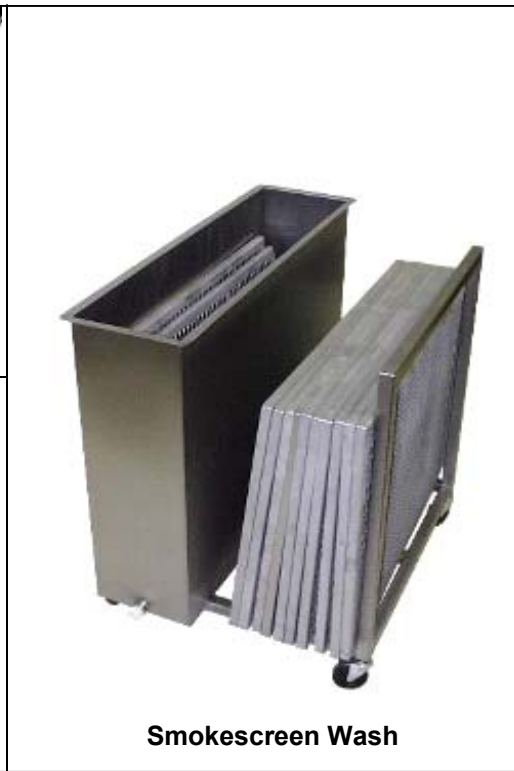

# MPBS Industries Staplers and Paper Cutters



# Steel It Coating



**Steel It: Coating**  
**Polyurethane Finish**  
Gallon: (80119), Quarts: (80118)



**Steel It: General Purpose**  
**14 oz. Spray Can**  
(80118)



**Steel It: Coatings Alkyd Primer**  
Gallon: (80119-PR)  
Quarts: (80118-PR)



**Steel It: Epoxy Primer Coating**  
**2 Parts**  
Gallon: (80121-PR)  
Quarts: (80120-PR)



**Steel It: Epoxy Reducer**  
(80122)



**Steel It: Epoxy Finish Coating**  
**2 Parts**  
Gallon: (80121)  
Quarts: (80120)



**Steel It: High Temperature**  
**Brush Grade Coating**  
Gallon: (80117-BG)



**Steel It: Heat Resistant**  
**14 oz. Spray Can**  
(80117)



# MPBS **Stainless Steel Sinks and Accessories**

INDUSTRIES

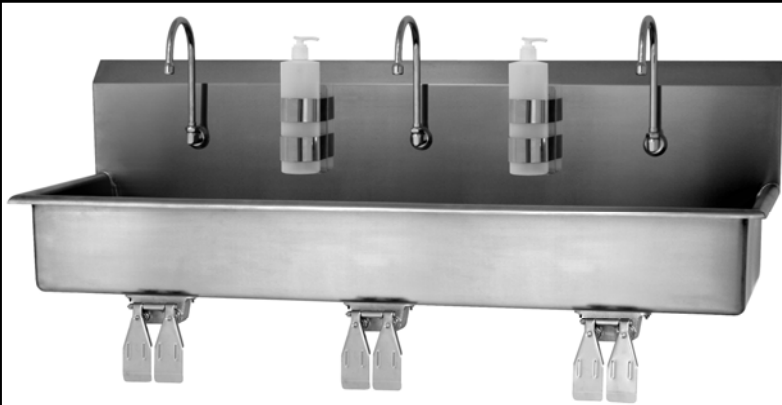

**3 Person Wall Mount Wash Station**  
(30040-HWS-56WS)



**Wall Mount**  
(30021)



**Double Knee Operated Valves**  
(30164)

**Sink Valve Knee Pedal**  
(30167)

**Drinking Fountain**  
(30034)



**Double Foot Operated Valves**  
(30032)



**Single Valve Long Foot Pedal**  
(30163)



**Soap Dispenser**  
(30031)



**Sink Valves Replacement Kit**  
(30034)



**Meat Wash**  
(30026)

**Flour Mount**  
(30020)



# MPBS Stainless Steel Work Tables

INDUSTRIES



**Stainless Steel Cutting Table w/ 3/4" Poly Top**  
(10210, 10210-02)



**Stainless Steel Cutting Table w/ 5/8" Poly Top**  
(10178, 10179, 10180, 10181, 10182, 10183, 10184, 10184-84, 10185, 10206, 10208)



**Stainless Steel Work Table No Undershef 30" Wide**  
(10226, 10227, 10228)

**Stainless Steel Work Table No Undershef 36" Wide**  
(10187, 10186, 10189, 10190, 10192, 10188)



**Stainless Steel Work Table w/ Shelf 30" Wide**  
(10226-SH72, 10227-SH84, 10227-SH96, 10228-SH120)  
**Stainless Steel Work Table w/ Shelf 36" Wide**  
(10193, 10194, 10195, 10196, 10197, 10198, 10199)



**Stainless Steel Sausage Stuffing Table with round Corners**  
(10112, 10113, 10114)

**Stainless Steel Sausage Stuffing Table with 45° Corners**  
(10119-SATAB-47, 10119-SATAB-57)



**Stainless Steel Utility Table w/ Shelf KD Style**  
(10220-TAKD-2424SS-3, 10220-TAKD-2430SS-3, 10220-TAKD-3048SS-3, 10220-TAKD-3060SS-3, 10220-TAKD-3072SS-3, 10220-TAKD-3096SS-3)  
**Galvanized Utility Table w/ Shelf KD Style**  
(10220-TAKD-2430SG-3, 10220-TAKD-3060SG-3, 10220-TAKD-3072SG-3)





**Check Temp 3 Thermometer**  
(70618-HI-98529)



**Mini/Max Hanging Thermometer**  
(70631)



**Non Contact Food Safety Thermometer**  
(70628)



**Pocket Type Thermometer**  
-40° - 160° F(70621)  
00° - 220° F(70622)



**Freezer/Refrigerator Thermometer**  
(70623)



**Digital Pocket Thermometer**  
(70638)



**Meat Testing Thermometer**  
(70619, 70620)



**Wall Thermometer**  
(70624)



**Roast Beef Thermometer**  
(70633)



**Certified Calibration Thermometer**  
(70626)





# MPBS **Trief Blades and Busch Filter Kit**

INDUSTRIES



**Busch Exhaust Filter Kit: ZBU993.120.02**



**Busch Exhaust Filter Kit: ZBU993.900.556**



**Busch Exhaust Filter Kit: ZBU993.902.118**



**Trief Original Serrated Blade: ZTR-13326**  
182 x 16 x 1 mm



**Trief Original Serrated Blade: ZTR-12401**  
311 x 27 x 1.5 mm



**Trief Original Smooth Blade: ZTR-12433**  
311 x 27 x 1.5 mm



**Trief Original Smooth Blade: ZTR-13313**  
182 x 16 x 1.5 mm



**Trief Original Smooth Blade: ZTR-13312**  
182 x 16 x 1 mm





**Film Axle**  
(81320-113056)



**Heat Element**  
(81336)



**Teflon Cover**  
(81323-81324)



**Cut Off Rod**  
(81320-113110)



**Knob for Thermostat**  
(81320-113259)



**Fuse**  
(81320-113152)

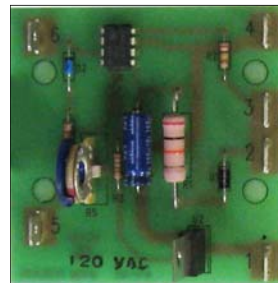

**Circuit Board**  
(81320-113101)



**Electric Wire Connector**  
(81320-113136)



**Bearing Block Set**  
(81320-113072)



**Rocker On/Off Switch Lighted**  
(81320-113224)



**Thermostat**  
(81320-113267)



**Fuse Holder**  
(81320-113144)



**Core Adapter / Pin Unit**  
(81320-113081)



**Core Adapter / Wing Unit**  
(81320-113099)

